

Article number: 20131177

Description: E+G Ball knob DIN 319-ST-32-B12-K

Measures

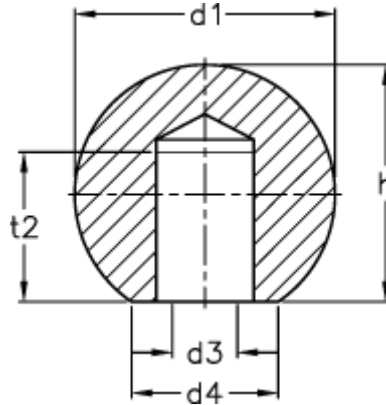

d1	= 32
d3 H7	= B12
d4	= 18
h	= 29.0
t2 min.	= 17